

Kodak EasyShare Z712 IS zoom digital camera

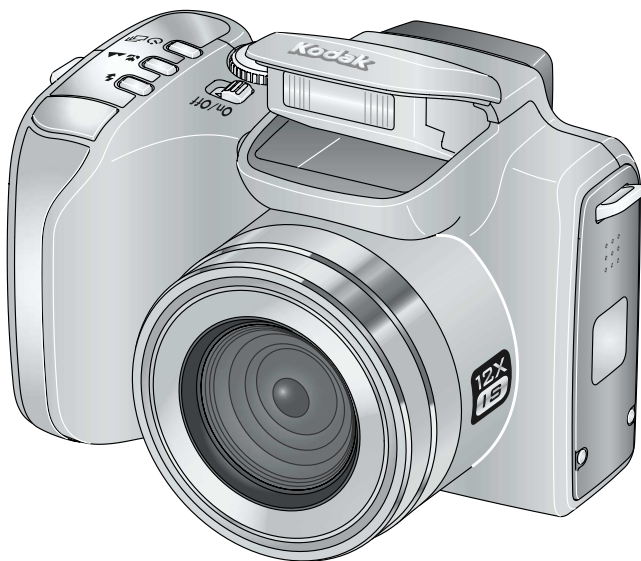

User's guide

www.kodak.com

For interactive tutorials, www.kodak.com/go/howto

For help with your camera, www.kodak.com/go/z712support

Kodak

Eastman Kodak Company

Rochester, New York 14650

© Eastman Kodak Company, 2007

All screen images are simulated.

Kodak and EasyShare are trademarks of Eastman Kodak Company.

P/N 4J6066_en

Front view

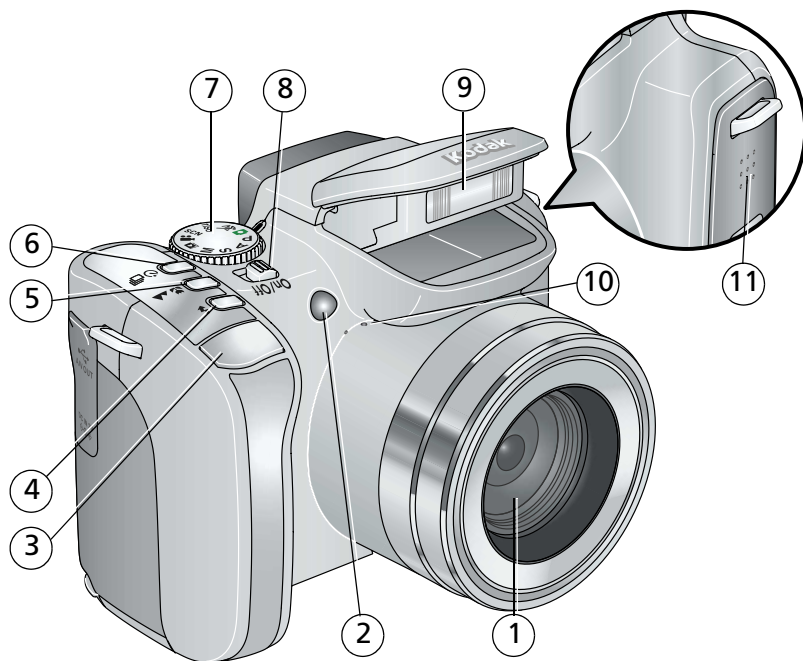

- | | | | |
|---|--|----|---------------|
| 1 | Lens | 7 | Mode dial |
| 2 | Low-light assist, Self-timer light, Video light | 8 | On/Off switch |
| 3 | Shutter button | 9 | Flash |
| 4 | Flash button | 10 | Microphone |
| 5 | Focus button (Close-up/Macro, Landscape, Manual Focus) | 11 | Speaker |
| 6 | Drive button (Self-timer, Burst, Exposure Bracketing) | | |

Back view

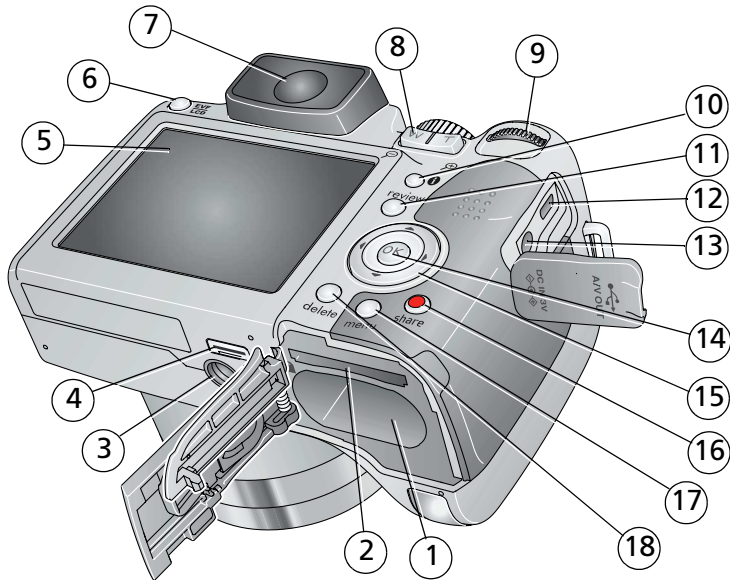



- | | |
|--------------------------------------|--|
| 1 Battery compartment | 10 Info button |
| 2 Slot for optional SD or MMC card | 11 Review button |
| 3 Tripod socket | 12 USB, A/V Out |
| 4 Dock connector | 13 DC-In (3V)  , for optional AC adapter |
| 5 LCD | 14 OK button |
| 6 EVF/LCD button | 15   |
| 7 EVF (Electronic viewfinder) | 16 Share button |
| 8 Zoom (Wide Angle/Telephoto) button | 17 Menu button |
| 9 Jog dial | 18 Delete button |

Table of contents

1	Setting up your camera	1
	Attaching the lens cap and strap	1
	Loading the battery	2
	Turning on the camera	3
	Setting the language and date/time	3
	Storing pictures on an SD or MMC card	4
2	Taking pictures/videos	5
	Taking a picture	5
	Using optical zoom	8
	Using the Flash button	9
	Using the Focus button	10
	Using the Drive button	11
	Using the camera Help button	13
	Using the Info button	14
3	Working with pictures/videos	16
	Reviewing pictures and videos	16
	Deleting pictures and videos	17
	Cropping pictures	18
	Using Kodak Perfect Touch technology	18
	Editing videos	19
	Using the histogram to view picture exposure	20
	Running a slide show	21
	Viewing pictures/videos in different ways	22
	Selecting multiple pictures/videos	23
	Copying pictures and videos	24
	What the review icons mean	25

4	Doing more with your camera	26
	Capture modes	26
	Using the Menu button	28
	Using the Setup menu	31
	Taking panoramic pictures	34
	P, A, S, and M modes	35
	Sharing your pictures	37
5	Transferring and printing pictures	43
	Installing the software	43
	Transferring pictures	44
	Printing pictures	45
	Accessories for your camera	47
6	Troubleshooting	48
	Camera problems	48
	Computer/connectivity problems	50
	Picture quality problems	50
	Direct printing (PictBridge) problems	51
7	Getting help	52
	Helpful links	52
8	Appendix	54
	Camera specifications	54
	Care and maintenance	56
	Storage capacities	57
	Important safety instructions	57
	Battery life	58
	Upgrading your software and firmware	59
	Limited warranty	59
	Regulatory compliance	61

1

Setting up your camera

Attaching the lens cap and strap

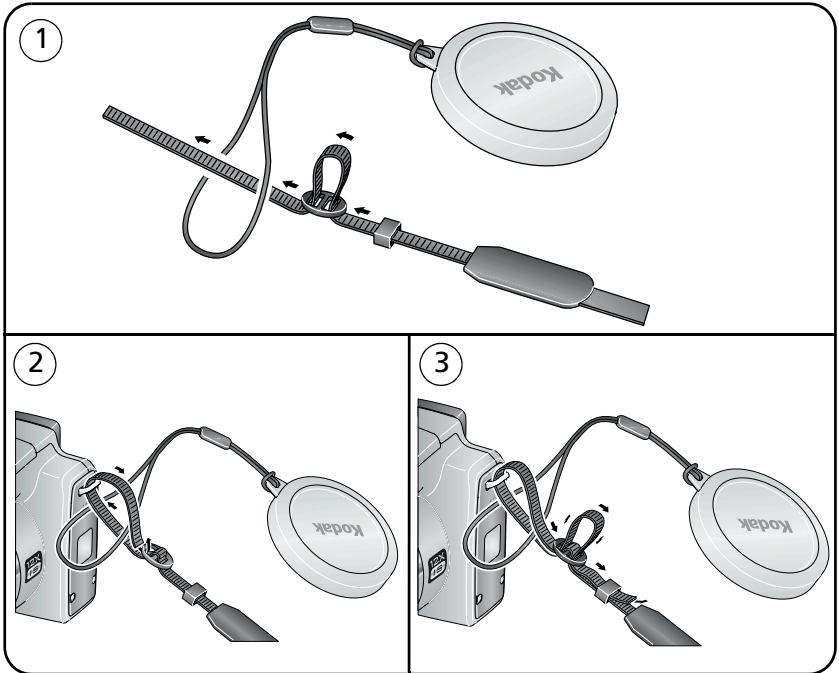

Loading the battery

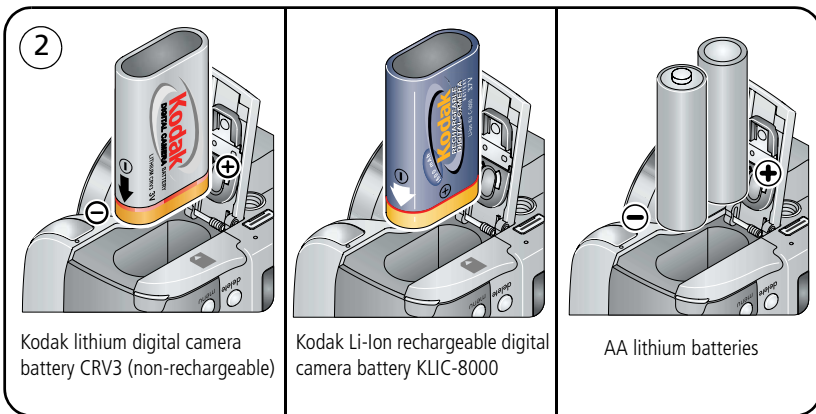
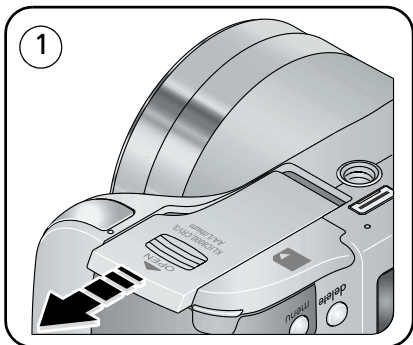

To replace batteries and extend battery life, see [page 58](#).

Turning on the camera

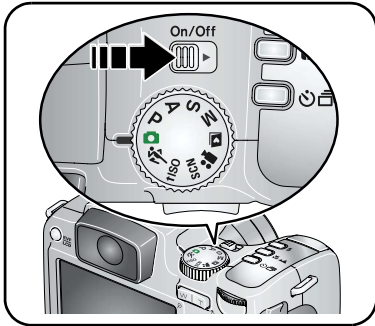

Setting the language and date/time

A diagram of the camera's control panel. The screen on the left shows a menu with options like '2 2007' and 'en done'. Arrows point from the screen to the 'OK' button and the 'Mode' dial. The 'OK' button is a circular button with the letters 'OK' on it. The 'Mode' dial is a circular dial with various settings. The 'delete' button is a small button with the word 'delete' on it. The 'share' button is a red button with the word 'share' on it. The 'review' button is a small button with the word 'review' on it. The 'A/V OUT' port is a small port with the text 'A/V OUT' next to it. The 'DC IN 3V' port is a small port with the text 'DC IN 3V' next to it.

Language:

- 1 ▲/▼ to change.
- 2 OK to accept.

Date/Time:

- 1 At the prompt, press OK.
- 2 ▲/▼ to change.
◀/▶ for previous/next field.
OK to accept.

NOTE: To change the date/time and language in the future, use the Menu button (see page 32).

Storing pictures on an SD or MMC card

Your camera has internal memory. You can purchase SD or MMC cards to store more pictures and videos. We recommend Kodak SD or MMC cards. (Visit www.kodak.com/go/z712accessories.)

NOTE: When using the card for the first time, format it in this camera before taking pictures ([see page 33](#)).

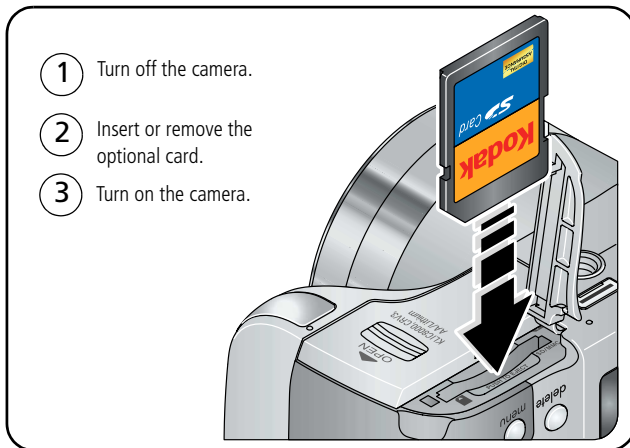

CAUTION:

A card can only be inserted one way; forcing it may cause damage. Inserting or removing a card while it is being accessed by the camera may damage pictures, card, or camera.

To choose a storage location for pictures/videos, [see page 31](#). For storage capacities, [see page 57](#).

2 Taking pictures/videos

Taking a picture

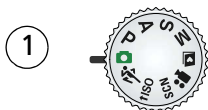

- 2 Press the EVF/LCD button to turn on:
- LCD or
 - EVF (electronic viewfinder)

- 3 Press the Shutter button halfway to focus and set exposure.

When the AF/AE indicator turns green, press the Shutter button completely down.

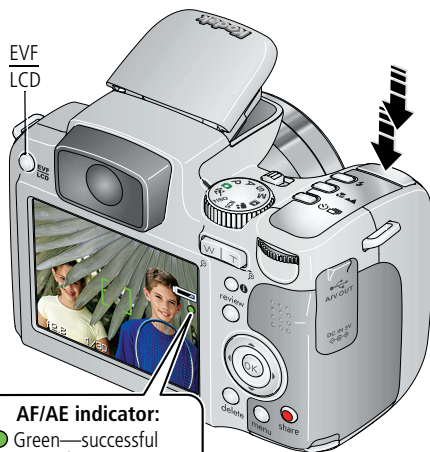

AF/AE indicator:

- Green—successful
- Red—failed
- AF** Failed focus
- AE** Failed exposure

NOTE: After you take a picture, the EVF/LCD displays a quickview for approximately 5 seconds. The picture is saved unless you press the Delete button.

Using the auto-focus framing marks (for pictures)

When using the LCD or EVF as a viewfinder, framing marks indicate the camera focus area. The camera attempts to focus on foreground subjects, even if the subjects are not centered in the scene.

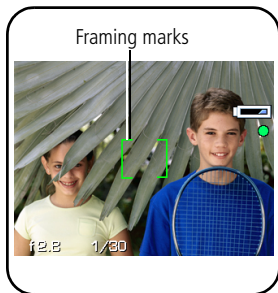

- 1 Press the Shutter button **halfway**.

When the framing marks turn green, focus is accomplished.

- 2 If the camera is not focusing on the desired subject (or if the framing marks disappear), release the Shutter button and recompose the scene.
- 3 Press the Shutter button **completely down** to take the picture.

NOTE: Framing marks do not appear in all modes. When you use Focus Zone and set Center Zone, the framing marks are fixed at Center Wide.

Taking a video

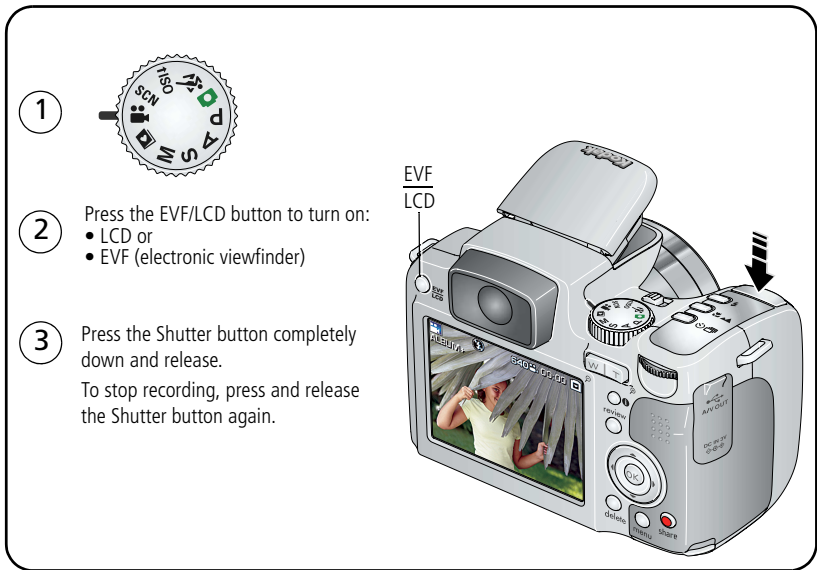

NOTE: After you take a video, the EVF/LCD displays a quickview for approximately 5 seconds.

To play/pause the video during the quickview, press OK. The video is saved unless you press the Delete button.

Using optical zoom

Use optical zoom to get up to 12X closer to your subject. You can change optical zoom before (but not during) video recording.

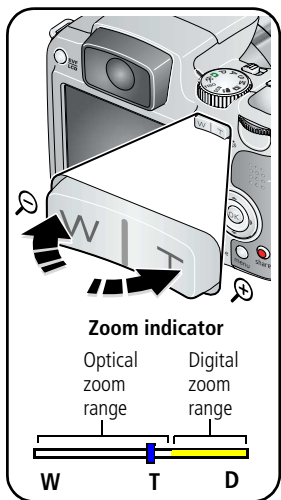

- 1 Use the EVF or LCD to frame your subject.
- 2 Press Telephoto (T) to zoom in. Press Wide Angle (W) to zoom out.

The zoom indicator shows zoom status.

- 3 Take the picture or video.

NOTE: To get a focused picture every time, remember:

- Always use the auto focus framing marks, [page 6](#).
- If you are using no zoom (1X, wide angle), you can be as close as 24 in. (60 cm) to your subject. (For Close-up/Macro mode, see [page 10](#)).
- As you zoom in (up to 12X), you need to move further from your subject.

Using digital zoom

Use digital zoom in any Still mode to get up to 4.2X magnification beyond optical zoom. To turn on/off digital zoom, or change how it is accessed, [see page 32](#).

- 1 Press the Telephoto (T) button past the optical zoom limit (12X).

The zoom indicator shows zoom status.

- 2 Take the picture or video.

NOTE: You cannot use digital zoom for video recording. You may notice decreased image quality when using digital zoom. The blue slider on the zoom indicator pauses and turns red when the picture quality reaches the limit for an acceptable 4 x 6-in. (10 x 15 cm) print.

Using the Flash button

Use the flash when you take pictures at night, indoors, or outdoors in heavy shadows.

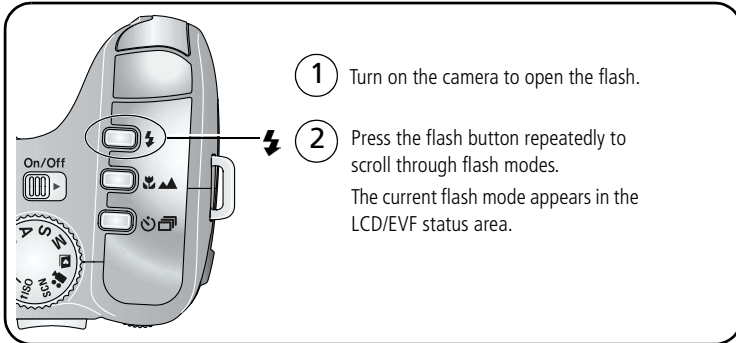

Mode	Icon	The flash fires
Auto Flash		When the lighting conditions require it.
Off		Never
Fill		Every time you take a picture, regardless of the lighting conditions. Use when the subject is in shadow or is "backlit" (when light is behind the subject). In low light, hold the camera steady or use a tripod.
Red Eye		The flash fires once so the eyes become accustomed to the flash, then fires again when the picture is taken.

Zoom position	Flash distance
Wide angle	1.6–25.6 ft (0.5–7.8 m)
Telephoto	4–14.4 ft (1.2–4.4 m)



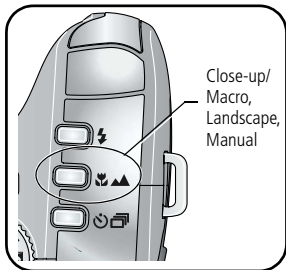

Using the Focus button

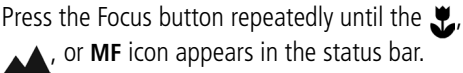
Press the Focus button  to have more control over camera focusing.









- 1 Turn the Mode dial to P, A, S, or M mode (see [page 35](#)).
- 2 Press the Focus button repeatedly until the  or **MF** icon appears in the status bar.
- 3 Take a picture.

NOTE: After you take the picture, the camera stays in the Close-up/Macro, Landscape, or Manual Focus setting. To exit, either press the  button until the icon turns off or turn off the camera.

Mode	Icon	Purpose	Details
Close-up/ Macro		To gain sharpness and detail in pictures at close range	Use available light instead of flash if possible. Camera automatically sets the focus distance depending on the zoom position: Wide angle: 4.7–27.6 in. (12–70 cm) Telephoto: 3.9–4.3 ft (1.2–1.3 m)
Landscape		To gain sharpness of distant scenes	Camera uses infinity auto-focus. Auto-focus framing marks are not available in Landscape.
Manual Focus	MF	Control focusing	The focus icon shows the direction and distance of the focus (to infinity). Press  to view 2X magnification of the central area of focus. During magnification, press  to adjust focal length. Digital zoom is not available in manual focus mode.
Normal	(none)	Auto focus	The camera focuses when the Shutter button is pressed halfway down.

Using the Drive button

Mode	Icon(s)	Purpose
Self-timer	  2X 	See Using the self-timer
Burst	 	See page 12
Exposure Bracketing		See page 13
Normal	(none)	Normal picture-taking

Using the self-timer



- 1 Place camera on a tripod or flat surface.
- 2 In any Still mode, press the Drive button.
 - Once for a 10-sec. delay (so you have time to get into the scene)
 - Again for a 2-sec. delay (for a steady, shutter release on a tripod)
 - Again for 2 pictures (after a 10- and 18-second delay)
- 3 Compose the scene.
- 4 Press the Shutter button halfway, then completely down.

 The picture is taken after the delay.

To cancel the Self-timer before the picture is taken, press the Drive button. (The Self-timer setting remains active.)



Use the same procedure to take a video, but:

- Turn the Mode dial to Video .
- Press the Shutter button completely down.

NOTE: The video stops when no storage space remains. Only the 2- and 10-second options are available in video mode.

Using burst

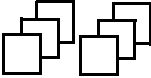
Press the Drive button to choose a burst mode.

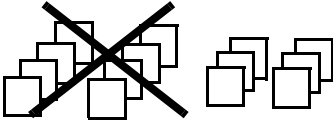
Mode	Icon	Description	Purpose
First Burst		Camera takes up to 6 pictures while the Shutter button is pressed. 	Capture an expected event. Example: A person swinging a golf club.
Last Burst		Camera takes up to 30 pictures while the Shutter button is pressed. When the Shutter button is released, only the last 6 pictures are saved. 	Capture an event when the precise timing is uncertain. Example: A child blowing out birthday candles.

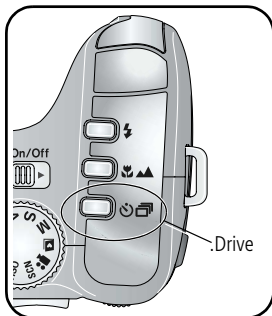

- 1 In most Still modes, press the Drive button repeatedly to choose an option.
- 2 Press the Shutter button **halfway** to focus and set exposure.
- 3 Press the Shutter button **completely down and hold it** to take pictures.

The camera stops taking pictures when you release the Shutter button, when the pictures are taken, or when there is no more storage space.

NOTE: During Quickview, you can delete all pictures in the burst series. To delete selectively, do so in Review (see [page 17](#)). Burst is not available when shutter speeds are longer than 0.5 seconds.

Using exposure bracketing

Use exposure bracketing to determine the best exposure (light) level for your conditions. During exposure bracketing, the camera takes 3 pictures:

- One at + (above normal) exposure
- One at 0 (normal) exposure
- One at - (below normal) exposure

Evaluate the 3 pictures, and decide which exposure level is right for you. (Burst is not available in all modes.)

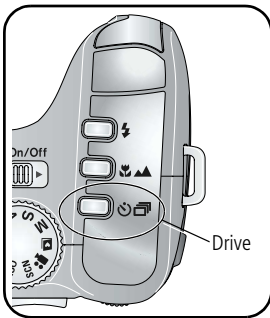

- 1 Press the Drive button repeatedly to choose Exposure Bracketing.
- 2 Press the Shutter button **halfway** to focus and set exposure.
- 3 Press the Shutter button **completely down** to take the 3 pictures.

To evaluate the pictures, press the Review button.

NOTE: To widen or narrow the exposure bracketing interval (the difference in exposure compensation), [see page 29](#).

Using the camera Help button

To better understand each menu option, use camera Help. Highlight a menu choice, then press the Info **i** button.

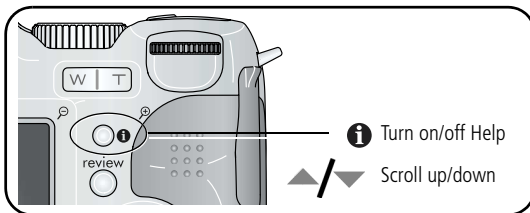

Using the Info button

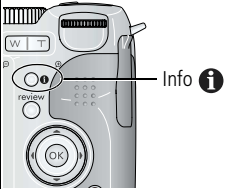
Repeatedly press info i	In	To turn on/off
	picture-taking mode	status icons, histogram
	review mode	status icons, histogram, and picture/video information
	any menu	Help

What the capture icons mean

Capture modes—no buttons pressed

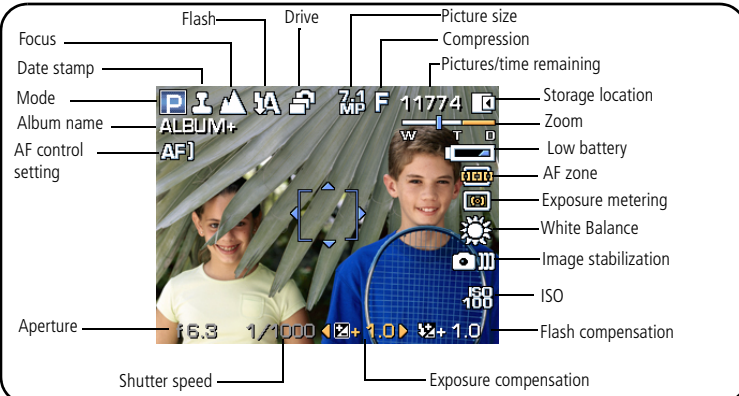

Focus

Date stamp

Mode

Album name

AF control setting

Aperture

Shutter speed

Flash

Drive

Picture size

Compression

Pictures/time remaining

Storage location

Zoom

Low battery

AF zone

Exposure metering

White Balance

Image stabilization

ISO

Flash compensation

Capture modes—shutter pressed halfway

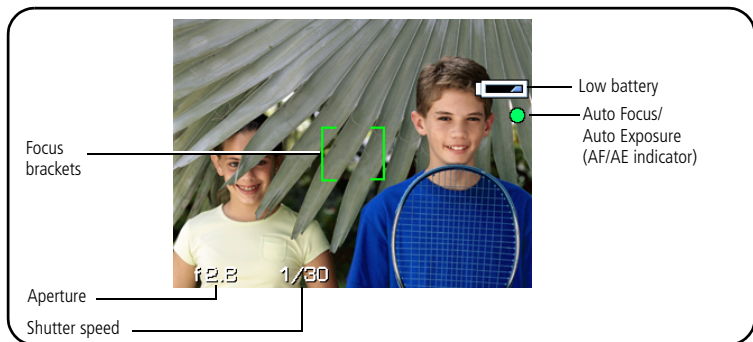

3

Working with pictures/videos

Reviewing pictures and videos

Press the Review button to view and work with your pictures and videos.

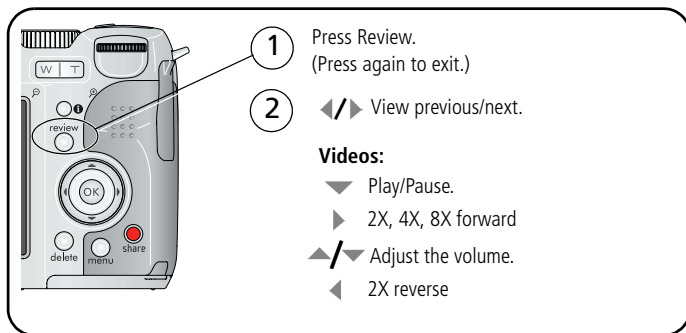

NOTE: If you have pictures/videos on card and in internal memory, you can scroll ◀/▶ from one storage location to the other. A video's duration is displayed at the top of the LCD.

Magnifying a picture

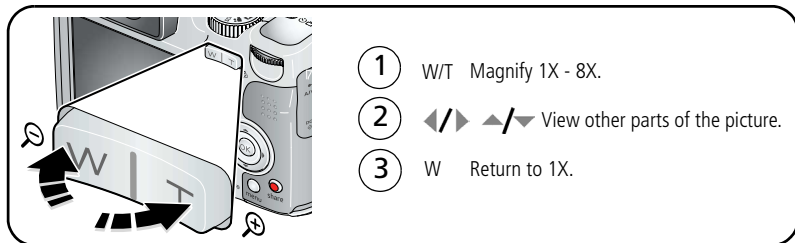

Deleting pictures and videos

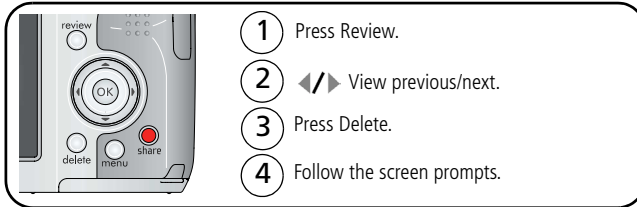

Using the undo delete feature

If you accidentally delete a picture, you may be able to use Undo Delete to retrieve it. This feature is only available immediately after you delete a single picture.

Protecting pictures and videos from deletion

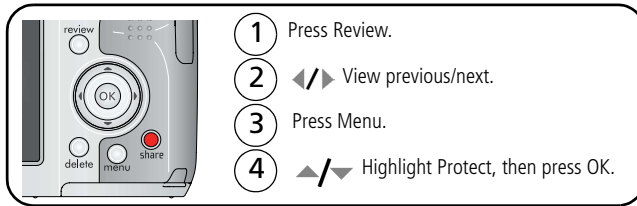

The picture /video cannot be deleted. The Protect icon  appears with the protected picture/video.

Press the Menu button to exit the menu.



CAUTION:

Formatting a card deletes all (including protected) pictures/videos. Formatting internal memory deletes all pictures/videos, email addresses, album names, and favorites.

Cropping pictures

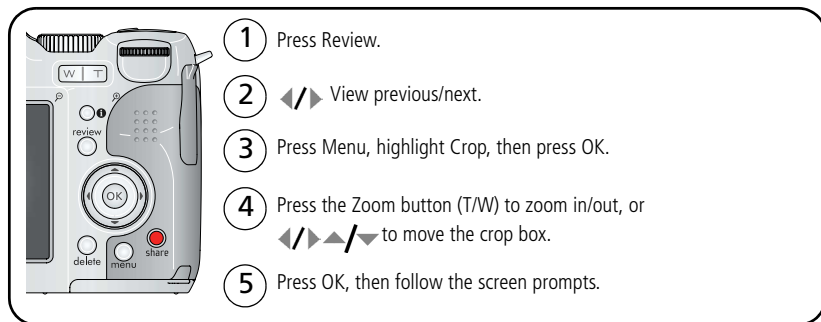

The picture is copied, then cropped. The original picture is saved. A cropped picture cannot be cropped again on the camera.

Press the Menu button to exit the menu.

Using Kodak Perfect Touch technology

Kodak Perfect Touch technology helps ensure better, brighter pictures.

- 1 Press the Review button.
- 2 Press ◀/▶ for previous/next picture.
- 3 Press the Menu button, choose Perfect Touch tech, then press OK.

The enhancement is previewed in a split screen. Press ◀/▶ to view other parts of the picture.

- 4 Press OK. Follow the screen prompts to replace the original picture or to save the enhanced picture as a new one.

Enhanced pictures cannot be enhanced again on the camera. Kodak Perfect Touch technology can only be used with pictures, not video.

- Press the Menu button to exit the menu.

Editing videos

You can do incredible things with your videos!

Making a picture from a video

You can choose a single frame from a VGA video, then make a picture suitable for a 4 x 6-inch (10 x 15 cm) print. (For video settings, [see page 28.](#))

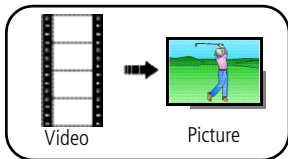

- 1 Press the Review button, then ◀/▶ to find a video.
- 2 Press the Menu button, choose Make Picture, then press OK.
- 3 Follow the screen prompts.
A picture is created. (The original video is saved.)
■ Press the Menu button to exit the menu.

Trimming a video

You can trim an unwanted start or end from a video, saving only the desired portion.

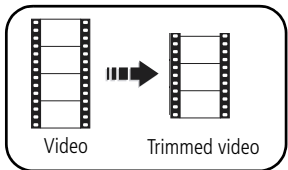

- 1 Press the Review button, then ◀/▶ to find a video.
- 2 Press the Menu button, choose Edit Video, then press OK. Choose Trim, then press OK.
- 3 Follow the screen prompts.
The video is trimmed. (You can save it as a new video or replace the original.)
■ Press the Menu button to exit the menu.

Making a video action print

From a video, you can make a 4-, 9-, or 16-up picture, suitable for a 4 x 6-inch (10 x 15 cm) print.

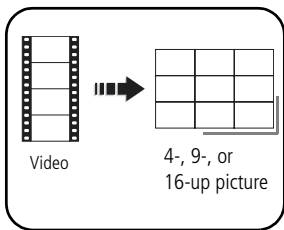

- 1 Press the Review button, then ◀/▶ to find a video.
- 2 Press the Menu button, choose Edit Video, then press OK. Choose Action Print, then press OK.
- 3 Choose an 4, 9, or 16, then press OK.

The camera creates a picture that includes the first and last frames, then 2, 7, or 14 equally spaced frames.

- Press the Menu button to exit the menu.

Using the histogram to view picture exposure

Use the histogram to evaluate the distribution of light before or after you take a picture. If the peak is to the right of the graph, the subject is bright; if it's to the left, the subject is dark. Optimal exposure is achieved when the peak is in the middle of the histogram.

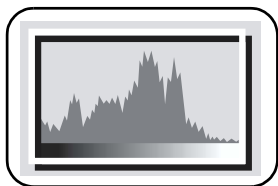

To turn on the histogram in P, A, S, or M mode or in Review, press the Info ⓘ button until the histogram appears.

NOTE: If a scene is dark or light, you can adjust the exposure compensation (see [page 35](#)) before taking the picture. The flash may affect a picture's light and shadow and will not affect the histogram until after the picture is taken.

Running a slide show

Use the Slide Show to display your pictures and videos on the camera. To run a slide show on a television or on any external device, see [page 22](#). To save battery power, use an optional Kodak 3-volt AC adapter. (Visit www.kodak.com/go/z712accessories.)

Starting the slide show

- 1 Press the Review button, then press the Menu button.
 - 2 Press $\blacktriangle/\blacktriangledown$ to highlight Slide Show, then press OK.
 - 3 Press $\blacktriangle/\blacktriangledown$ to highlight Begin Show, then press OK.
- To interrupt the Slide Show, press OK.

Changing the slide show display interval

The default interval setting displays each picture for 5 seconds. You can set the display interval from 3 to 60 seconds.

- 1 On the Slide Show menu, press $\blacktriangle/\blacktriangledown$ to highlight Interval, then press OK.
- 2 Select a display interval.
- 3 To scroll through the seconds quickly, press and hold $\blacktriangle/\blacktriangledown$.
- 4 Press OK.

The interval setting remains until you change it.

Running a continuous slide show loop

When you turn on Loop, the slide show is continuously repeated.

- 1 On the Slide Show menu, press $\blacktriangle/\blacktriangledown$ to highlight Loop, then press OK.
- 2 Press $\blacktriangle/\blacktriangledown$ to highlight On, then press OK.
- 3 Press $\blacktriangle/\blacktriangledown$ to highlight Begin Show, then press OK.

The slide show repeats until you press OK or until battery power is exhausted. The Loop feature remains until you change it.

Displaying pictures and videos on a television

You can display pictures/videos on a television, computer monitor, or any device equipped with a video input. To connect the camera to a television, use an optional A/V cable (visit www.kodak.com/go/z712accessories).

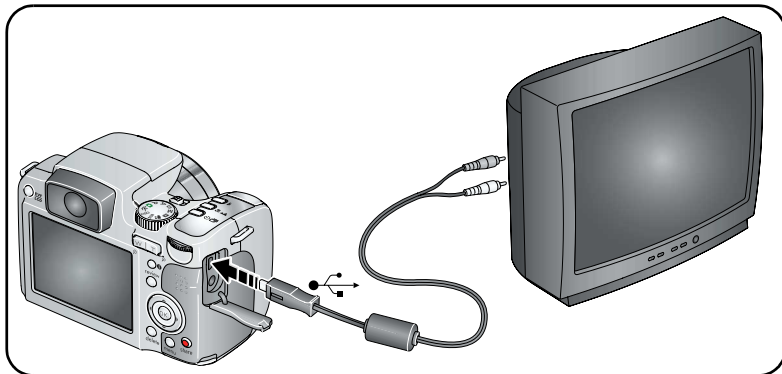

NOTE: Ensure that the Video Out setting (NTSC or PAL) is correct (see page 32). The slide show stops if you connect or disconnect the cable while the slide show is running. (Image quality on a television screen may not be as good as on a computer monitor or when printed.)

Viewing pictures/videos in different ways

Viewing as thumbnails (multi-up)

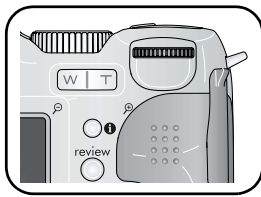

- 1 Press the Review button.
- 2 Press the Zoom Wide Angle (W) button to change from single-picture view to multi-up thumbnails.
- 3 Press Telephoto (T) to return to single-picture view.
 - To select multiple pictures/videos, see [page 23](http://www.kodak.com/go/z712accessories).
 - Press the Review button to exit Review.

Viewing by date, album, or image storage

- 1 Press the Review button, then press the Menu button.
- 2 Press $\blacktriangle/\blacktriangledown$ to highlight View By, then press OK.
- 3 Press $\blacktriangle/\blacktriangledown$ to highlight All (default), Date, Album, or Image Storage, then press OK.
 - Press $\blacktriangle/\blacktriangledown$ $\blacktriangleleft/\blacktriangleright$ to highlight a date, album, or image storage, then press the T button. To return to the list, press the W button.
 - Press the Review button to exit Review.
 - For more about albums, see [page 40](#).

Selecting multiple pictures/videos

Use the multi-select feature when you have two or more pictures/videos to print, transfer, or delete. (Multi-select is used most effectively in Multi-Up mode, [page 22](#).)

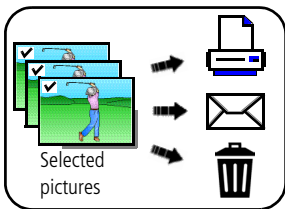

- 1 Press the Review button, then $\blacktriangleleft/\blacktriangleright$ to find a picture/video.
- 2 Press OK to select pictures/videos.

A check mark appears on the picture. You can now print, email, or delete the selected pictures. You can press OK a second time to remove a check mark.

Copying pictures and videos

You can copy pictures and videos from a card to internal memory or from internal memory to a card.

Before you copy, make sure that a card is inserted in the camera.

Copy pictures or videos:

- 1 Press the Review button, then press the Menu button.
- 2 Press ▲/▼ to highlight Copy, then press OK.
- 3 Press ▲/▼ to highlight Memory Card or Internal Memory, then press OK.
- 4 Press ▲/▼ to highlight an option: Picture/Video, All Date, Selected, All Album, All Memory Card, All Internal Memory.
- 5 Press OK.

NOTE: Pictures and videos are copied, not moved. To remove pictures from the original location after copying, delete them (see [page 17](#)). Tags that you applied for print, email, and favorites are not copied. Protection settings are not copied. To apply protection to a picture or video, see [page 17](#).

What the review icons mean

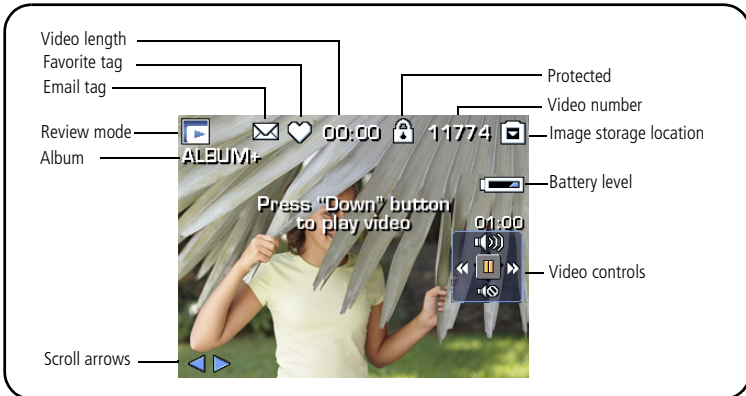
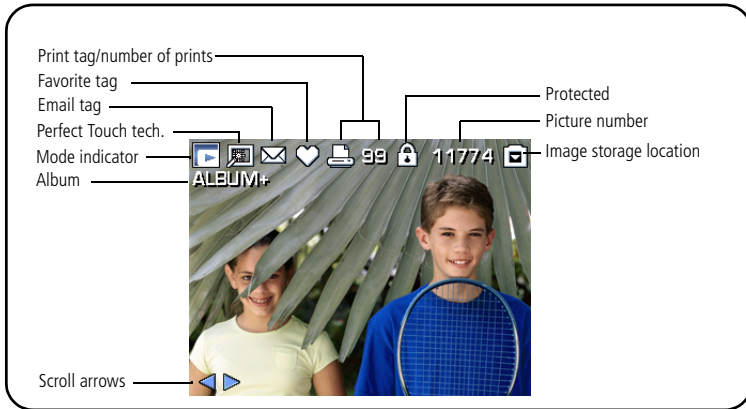



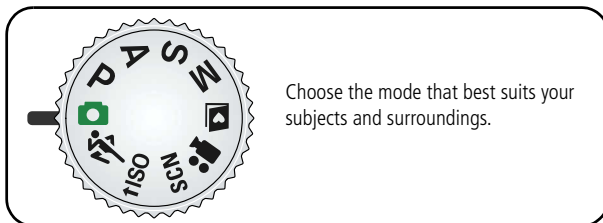

4

Doing more with your camera

Capture modes



Capture mode	For
 Smart Scene	General picture taking—offers an excellent balance of image quality and ease of use. When the Shutter button is pressed halfway, faces are detected, the scene is analyzed, and the best settings are applied.
P, A, S, M	More creative control. (See page 35 .) Program, Aperture Priority, Shutter priority, and Manual mode.
 Favorites	Viewing favorite pictures. (See page 39 .)
 Video	Video with sound. (See page 7 .)
SCN Scene	Point-and-shoot simplicity when taking pictures under special conditions. (See SCN (Scene) modes, page 27 .)
 High-ISO	People in low-light scenes.
 Sport	Subjects that are in motion. Shutter speed is fast. The camera pre-settings are Multi-Pattern Exposure Metering, Multi-Zone focus.

SCN (Scene) modes

1 Turn the Mode dial to **SCN**.

2 Press $\blacktriangle/\blacktriangledown$ $\blacktriangleleft/\blacktriangleright$ to highlight a SCN mode and view its description.

NOTE: If the SCN mode description turns off, press OK.

3 Press OK (or keep the SCN mode highlighted) to choose the SCN mode.

To return to Smart Scene mode, turn the mode dial to Smart Scene .

SCN mode	For
Portrait	Full-frame portraits of people. Subject is sharp and the background is indistinct. Position your subject at least 6 ft (2 m) away and fill the frame with a head and shoulder pose. Use Telephoto to exaggerate background blur.
Panorama Left-Right, Right-Left	See page 34 .
Landscape	Distant scenery. Flash does not fire. Auto-focus framing marks (page 6) are not available in Landscape.
Night Portrait	Reducing red eye of people in night scenes or low-light conditions. NOTE: To avoid blur, place the camera on a tripod.
Night Landscape	Distant scenery at night. Flash does not fire. NOTE: To avoid blur, place the camera on a tripod.
Snow	Bright snow scenes.
Beach	Bright beach scenes.
Text	Documents. Place the camera on a tripod.
Fireworks	Fireworks. NOTE: To avoid blur, place the camera on a tripod.
Flower	Close-ups of flowers or other small subjects in bright light.
Manner/ Museum	Quiet occasions, like a wedding or lecture. Flash and sound are disabled. Place the camera on a tripod.
Children	Action pictures of children in bright light.

SCN mode	For
Backlight	Subjects that are in shadow or “backlit” (when light is behind the subject).
Candle Light	Subjects illuminated by candle light.
Sunset	Subjects at dusk.

Using the Menu button

You can change settings to get the best results from your camera.

NOTE: Some settings remain until you change them; others, until you change modes or turn off the camera.
Some modes offer limited settings.

- 1 Press the Menu button.
- 2 Press **▲/▼** to highlight a setting, then press OK.
- 3 Choose an option, then press OK.

Press Menu, ▲/▼ , and OK to access settings	Options
Picture Size Choose a picture resolution. For recommended print sizes, visit www.kodak.com/go/printsizes	7.1 MP —pictures are the highest resolution, largest file size 6.3 MP (3:2) — for printing on EasyShare printer docks and photo printers 5.0 MP —medium-to-large file size 3.1 MP —medium file size 2.2 MP (3:2) —printing on EasyShare printer docks and photo printers (at a lower resolution than 6.3 MP) 2.1 MP (16:9) —HDTV format 1.2 MP —email, Internet, or to conserve space
Video Size Choose a video resolution. Available only in Video mode.	640 x 480 (VGA) —best quality; largest file size 320 x 240 (QVGA) —lower quality; smaller file size

Press Menu, ▲/▼, and OK to access settings	Options
<p>Compression Choose how much compression is applied to pictures.</p>	<p>Fine—least compression; best quality, and largest file size. Standard (default)—medium compression; medium quality, and medium file size. Basic—most compression; lowest quality, and smallest file size.</p>
<p>White Balance Choose your lighting condition. Available only in PASM mode.</p>	<p>Auto (default)—automatically corrects white balance. Ideal for general picture taking. Daylight—for pictures in natural lighting. Tungsten—corrects the orange cast of household light bulbs. Ideal for indoor pictures under tungsten or halogen lighting without flash. Fluorescent—corrects the green cast of fluorescent lighting. Ideal for indoor pictures under fluorescent lighting without flash. Open Shade—for pictures in the shade in natural lighting.</p>
<p>Exposure Bracketing Interval Choose the difference in exposure compensation while using exposure bracketing.</p>	<p>+/- 0.3 EV (default) +/- 0.7 EV +/- 1.0 EV See page 13.</p>
<p>Exposure Metering Evaluate light levels at specific areas of a scene. Available only in PASM mode.</p>	<p>Multi-pattern (default)—evaluates lighting conditions throughout the image to give an optimum picture exposure. Ideal for general picture taking. Center-weight—evaluates the lighting conditions of the subject centered in the viewfinder. Ideal for backlit subjects. Spot—similar to Center-weight, except the metering is concentrated on a smaller area of the subject centered in the viewfinder. Ideal when you need exact exposure of a specific area in the picture. (If Focus Zone is set to Selectable Zone, the Exposure Metering spot moves with the focus zone.)</p>



Press Menu, ▲/▼, and OK to access settings	Options
<p>AF (Auto Focus) Zone Select a large or concentrated area of focus. Available only in PASM mode.</p>	<p>Multi-zone (default)—evaluates 5 zones to give an even picture focus. Ideal for general picture taking. Center-zone—evaluates the small area centered in the viewfinder. Ideal when precise focus of a specific area in the picture is needed. Selectable Zone—press ◀/▶▲/▼ to move the focus brackets and choose an auto focus zone.</p>
<p>Color Mode Choose picture color tones.</p>	<p>High Color Natural Color (default) Low Color Black & White Sepia EasyShare software also lets you change a color picture to black-and-white or sepia.</p>
<p>Sharpness Control picture sharpness. Available only in PASM mode.</p>	<p>High Normal (default) Low</p>
<p>Date Stamp Imprint the date on pictures.</p>	<p>On Off (default)</p>
<p>AF Control Choose an auto-focus setting.</p>	<p>Continuous AF (default)—because the camera is always focusing, there is no need to press the Shutter button halfway down to focus. Single AF—uses TTL-AF when the Shutter button is pressed halfway down.</p>

To access the Setup menu, see [page 31](#).





Using the Setup menu

Use Setup to customize your camera settings.

- 1 In any mode, press the Menu button.
- 2 Press  to highlight Setup , then press OK.
- 3 Press / to highlight a setting, then press OK.
- 4 Choose an option, then press OK.
- 5 Press the Menu button to exit.

Press Menu,  to highlight Setup,  /  to access settings, then OK.	Options
LCD Brightness	1, 2, 3, 4, 5 (3 is the default)
Image Storage Choose a storage location for pictures and videos.	Auto (default) —the camera uses the card if one is in the camera. If not, the camera uses internal memory. Internal Memory —the camera always uses internal memory, even if a card is installed.
Set Album Choose Album names. <i>You can apply different Set Album choices to videos and to pictures.</i>	On Off (default) Pre-select album names before you take pictures or videos. Then, all the pictures or videos you take are tagged with those album names. (See page 42 .)
Capture Frame Grid Turn framing grid on or off.	On Off (default)
Image Stabilizer Improves video stability, reducing the effects of camera shake.	Continuous (default) Single Off
Quickview Change Quickview default.	On (default) Off

Press Menu, ▶ to highlight Setup, ▲/▼ to access settings, then OK.	Options
<p>Advanced Digital Zoom Choose how digital zoom is employed.</p>	<p>Continuous—no pause between optical and digital zoom. Pause—after reaching 12X optical zoom, the zoom button must be released, then activated again to begin digital zoom. None (default)—digital zoom is disabled.</p>
<p>Orientation Sensor Orient pictures so that they are displayed with the correct side up.</p>	<p>On, On Transfer, or Off</p>
<p>Camera Sounds Choose a theme, or choose sounds for individual camera functions.</p>	<p>Default Sci-fi Fun Music None</p>
<p>Sound Volume</p>	<p>Off Low Medium (default) High</p>
<p>Date & Time</p>	<p>See page 3.</p>
<p>Auto Power Off Choose amount of inactivity time until camera turns off.</p>	<p>10 minutes 5 minutes 3 minutes (default) 1 minute</p>
<p>Video Out Choose the regional setting that lets you connect the camera to a television or other external device.</p>	<p>NTSC (default)—used in North America and Japan; most common format. PAL—used in Europe and China.</p>
<p>Language</p>	<p>Choose from available languages.</p>

<p>Press Menu,  to highlight Setup, / to access settings, then OK.</p>	<p>Options</p>
<p>Reset Camera Resets all settings to factory defaults.</p>	
<p>Format</p> <p> CAUTION: Formatting a card deletes all (including protected) pictures/videos. Formatting internal memory deletes all pictures/videos, email addresses, album names, and favorites.</p>	<p>Memory Card—deletes everything on the card; formats the card. Cancel—exits without making a change. Internal Memory—deletes everything in internal memory including email addresses, album names, and favorites; formats the internal memory.</p>
<p>About View camera information.</p>	

Taking panoramic pictures

Use panorama to “stitch” up to 3 pictures into a panoramic scene.

NOTE: For best results, use a tripod. (For a steady shutter release on a tripod, see [page 11.](#))

Only the panoramic picture is saved; individual pictures are not. Picture size is set to 5.0 MP.

Exposure and white balance are set with the first picture. The flash is set to Off.

- 1 Turn the Mode dial to SCN.
- 2 Press **◀/▶** to highlight Panorama Left-Right or Panorama Right-Left (depending on the direction you want to pan), then press OK (or keep the SCN mode highlighted).
- 3 Take the first picture.
After a quickview, the LCD displays the liveview and an “overlay” from the first picture.
- 4 Compose the second picture. Make the overlay from the first picture cover the same portion in the new picture. (You can press the Delete button to re-take a picture.)
- 5 If you are taking only 2 pictures, press OK to stitch them together.
After you take 3 pictures, the pictures are automatically stitched together.

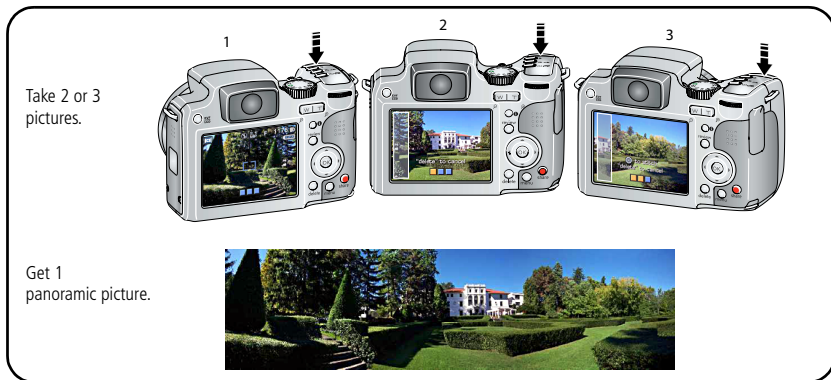

P, A, S, and M modes

Use these modes when you want more control over your camera and pictures.

Mode	When to use	Press Jog dial to control
P Program	Program mode offers the ease of auto shooting with full access to all menu options. The camera automatically sets the shutter speed and aperture (f-stop) based on the scene lighting.	Exposure compensation (how much light enters the camera), flash compensation, and ISO speed
A Aperture Priority	Use Aperture priority mode to control depth of field (the range of sharpness). The aperture setting may be affected by optical zoom.	Aperture, exposure compensation, flash compensation, and ISO speed
S Shutter Priority	Shutter priority mode is primarily used to prevent blur when your subject is moving. The camera automatically sets the aperture for proper exposure. (To prevent blur, use a tripod for slow shutter speeds.)	Shutter speed, exposure compensation, flash compensation, and ISO speed
M Manual	The highest level of creative control. (To prevent blur, use a tripod for slow shutter speeds.)	Aperture, shutter speed, flash compensation, and ISO speed

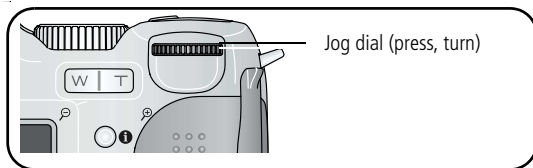

NOTE: Settings you change in P, A, S, or M modes apply only to pictures taken in those modes. For example, if you change the Color Mode to Sepia while in P, A, S, or M mode, you retain the default setting of Color for Smart Scene and SCN modes.

The settings, including Flash, are maintained for P, A, S, and M modes—even when you change modes or turn off the camera. Use Camera ([see page 33](#)) to reset P, A, S, or M mode to its default setting.

Changing P, A, S, or M mode settings

PASM modes control the aperture (f-number, also known as f-stop), shutter speed, and exposure compensation, flash compensation, and ISO. Use the Menu button to control all other settings.

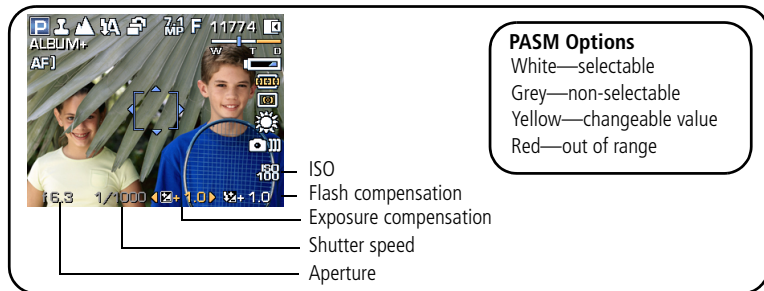

- 1 Turn the Mode dial to P, A, S, or M.

The mode options are displayed.

- 2 Use the Jog dial to move between settings, open a setting, or change a setting.

ISO—adjust the camera’s sensitivity to light. Higher ISO indicate greater sensitivity.

NOTE: A higher ISO may produce unwanted “noise” in a picture.

Flash Compensation—adjust flash brightness.

Exposure Compensation—adjust the exposure. If the picture is too light, decrease the setting; if it’s too dark, increase the setting.

Shutter speed—control how long the shutter stays open. A shaking hand icon  warns of slow shutter speeds. (Use a tripod for slow shutter speeds.)

Aperture—(also known as f-stop) control the size of the lens opening, which determines the depth of field.

- Smaller f-stop numbers indicate a larger lens opening; good for low-light.
- Larger f-stop numbers indicate a smaller lens opening; keeps the main subject sharp; good for landscapes and well-lit conditions.

Sharing your pictures

Press the Share button to tag your pictures/videos. When they are transferred to your computer, you can share them.

Tagging pictures for printing

- 1 Press the Share button. Press ◀/▶ to find a picture.
- 2 Press ▲/▼ to highlight Print, then press OK.*
- 3 Press ▲/▼ to select the number of copies (0–99). Zero removes the tag for that picture.
- 4 Optional: You can apply a print quantity to other pictures. Press ◀/▶ to find a picture. Keep the print quantity as is, or press ▲/▼ to change it. Repeat this step until the desired print quantity is applied to the pictures.
- 5 Press OK. Press the Share button to exit the menu.

The Print icon  appears in the status area. The default quantity is one.

* To tag all pictures in the storage location, highlight Print All, press OK, then indicate the number of copies. To remove print tagging for all pictures in the storage location, highlight Cancel Prints, then press OK.

Printing tagged pictures

When you transfer the tagged pictures to your computer, the EasyShare software print screen opens. For details on printing, see Help in EasyShare software.

For more information on printing from your computer, printer dock, PictBridge enabled printer, or card, see [page 45](#).

NOTE: For 4 x 6 in. (10 x 15 cm) prints, use one of the 3:2 picture sizes ([see page 28](#)).

Tagging pictures/videos for emailing

First—on your computer

Use Kodak EasyShare software to create an email address book on your computer. Then, copy up to 32 email addresses to the camera's internal memory. For details, see Help in EasyShare software.

Second—tag pictures/videos on your camera

- 1 Press the Share button. Press ◀/▶ to find a picture/video.
- 2 Press ▲/▼ to highlight Email, then press OK.
- 3 Press ▲/▼ to highlight an email address, then press OK.

To tag other pictures/videos with the same address, press ◀/▶ to scroll through them. When the picture you want is displayed, press OK.

To send the pictures/videos to more than one address, repeat step 3.

Selected addresses are checked.

- 4 To remove a selection, highlight a checked address and press OK. To remove all email selections, highlight Clear All.
- 5 Press ▲/▼ to highlight Exit, then press OK.
The Email icon appears in the status area.
- 6 Press the Share button to exit the menu.









Third—transfer and email

When you transfer the tagged pictures/videos to your computer, EasyShare software prompts you to send the pictures/videos. For details, see Help in EasyShare software.

Tagging pictures as favorites

Want to keep copies of your favorite pictures on your camera?

Start with the Share button!

1. Tag pictures as favorites	<ol style="list-style-type: none"> 1 Press the Share button. Press   to find a picture. 2 Press   to highlight Favorite, then press OK. <i>The Favorite icon  appears in the status area. To remove the tag, press OK again.</i>
2. View favorites on your camera	<ol style="list-style-type: none"> 1 Turn the Mode dial to Favorites . 2 Press   to view favorites.

The next time you transfer pictures to your computer, EasyShare software helps you make choices about your favorite pictures. Favorite pictures (smaller versions of the originals) are loaded to the Favorites section of your camera's internal memory.

NOTE: Videos tagged as favorites remain in the Favorites folder in EasyShare software. For details, see Help in EasyShare software.

Preventing camera favorites from synchronizing with the software

If you don't want to use the favorites feature:

- 1 Open EasyShare software.
- 2 From the Tools menu, select Cameras/Viewers > Sync and Transfer Manager.
- 3 Click to highlight your camera, then click Camera Favorites Album Properties.

NOTE: If your camera model is not visible, use the USB cable to connect your camera to the computer.

- 4 Drag the Internal Memory slider to 0%, then click OK.
- 5 Close the Sync and Transfer Manager window.



Camera favorites will no longer synchronize with EasyShare software.

To turn on the sync feature, select Yes, synchronize with my software.

To delete favorites from your camera, press the Delete button while in Favorites mode.



Optional settings

In Favorites mode, press the Menu button to access optional settings.

	Slide Show (page 21)
	Multi-Up (page 22)
	Setup Menu (page 31)

NOTE: Pictures taken at the 3:2 picture size are displayed at a 3:2 aspect ratio with a black bar at the top and bottom of the screen.

Printing and emailing favorites

- 1 Turn the Mode dial to Favorites . Press /  to find a picture.
- 2 Press the Share button.
- 3 Highlight Print or Email, then press OK.

NOTE: Favorites that were taken on this camera (not imported from another source) are good for prints up to 4 x 6 in. (10 x 15 cm).

Tagging pictures/videos for albums

Use the Album feature to tag the pictures/videos in your camera with album names.

First—on your computer

Use EasyShare software to create album names on your computer, then copy up to 32 album names to the camera's internal memory.

Second—on your camera

- 1 Press the Review button, then find the picture/video.
- 2 Press the Menu button.
- 3 Press **▲/▼** to highlight Album, then press OK.
- 4 Press **▲/▼** to highlight an album name, then press OK.

To add other pictures to the same album, press **◀/▶** to scroll through the pictures. When the picture you want is displayed, press OK.

- 5 Press **▲/▼** to highlight Exit, then press OK.

The album name appears with the picture. To add the pictures to more than one album, repeat step 4 and 5 for each album. A plus (+) after the album name means the picture was added to more than one album.

To remove a selection, highlight an album name and press OK. To remove all album selections, select Clear All, then exit the menu.

Third—transfer to your computer

When you transfer the tagged pictures/videos to your computer, EasyShare software opens and categorizes your pictures/videos in the appropriate album.

Pre-tagging for album names

Use the Set Album (Still or Video) feature to pre-select album names before you take pictures/videos. Then, all the pictures/videos you take are tagged with those album names.

First—on your computer

Use the EasyShare software to create album names on your computer. The next time you connect the camera to the computer, up to 32 album names are copied to the camera's internal memory.

Second—on your camera

- 1 In any mode, press the Menu button.
- 2 Press **▶** to highlight Setup , then press OK.
- 3 Press **▲/▼** to highlight Set Album, then press OK.
- 4 Press **▲/▼** to highlight an album name, then press OK.
- 5 Highlight Exit, then press OK.
- 6 Press the Menu button to exit the menu.

Your selections are saved. Your album selection is displayed on the LCD. A plus (+) after the album name means more than one album is selected.

Third—transfer to your computer

When you transfer the tagged pictures/videos to your computer, EasyShare software opens and categorizes your pictures/videos in the appropriate album. For details, see Help in EasyShare software.

5

Transferring and printing pictures

Installing the software

- 1 Close all open software applications before starting the installation.

NOTE: If running Windows OS and installing EasyShare software from the Kodak Web site, do not close the WinZip application. If prompted, allow EasyShare software to access the Internet.

- 2 Place the Kodak EasyShare software CD into the CD-ROM drive.

- 3 Load the software:

Windows OS—if the install window does not appear, choose Run from the Start menu and type **d:\setup.exe** where **d** is the drive letter that contains the CD.

Mac OS X—double-click the CD icon on the desktop, then click the Install icon.

- 4 Follow the on-screen instructions to install the software.

NOTE: When prompted, register your camera and software. Registering lets you sign up for information that keeps your system up-to-date. To register later, visit www.kodak.com/go/register.

- 5 If prompted, restart the computer.

For information on the software applications included on the Kodak EasyShare software CD, see Help in EasyShare software.

Transferring pictures

IMPORTANT: If your camera was packaged with a Kodak EasyShare dock, use the dock to transfer pictures to your computer. (See [page 47](#) and the dock user's guide for details.) If you do not have an EasyShare dock, use the USB cable (U-8) that came with your camera.

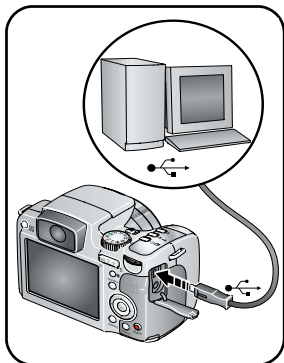

- 1 Turn off the camera.
- 2 Plug the labeled  end of the USB cable into the labeled USB port on your computer. See your computer user's guide for details.
- 3 Plug the other end of the USB cable into the USB port on the camera. The arrow icon on the cable should face you.
- 4 Turn on the camera.

EasyShare software opens on your computer. The software prompts you through the transfer process.

NOTE: Visit www.kodak.com/go/howto for an online tutorial on connecting.

Also available for transferring

You can also use these Kodak products to transfer your pictures and videos.

- Kodak EasyShare camera dock, Kodak EasyShare printer dock (see [page 47](#))
- Kodak multi-card reader, Kodak SD multimedia card reader-writer

Purchase these and other accessories at a dealer of Kodak products or www.kodak.com/go/z712accessories.

Printing pictures

Printing with a Kodak EasyShare printer dock

Dock your camera to the Kodak EasyShare printer dock and print directly—with or without a computer. Purchase this and other accessories at a dealer of Kodak products or www.kodak.com/go/z712accessories.

Direct printing with a PictBridge enabled printer

Your camera features PictBridge technology, so you can print directly to PictBridge enabled printers. You need:

- Camera with fully charged batteries, or with optional Kodak 3-volt AC adapter
- PictBridge enabled printer
- USB cable included with your camera

Connecting the camera to a PictBridge enabled printer

- 1 Turn off the camera and printer.
- 2 Optional: If you have a Kodak 3-volt AC adapter (optional accessory), plug it into the camera and into an electrical outlet.

IMPORTANT: *Do not use the AC adapter included with the Kodak EasyShare camera dock or printer dock to power your camera.*

- 3 Connect the USB cable from the camera to the printer. (See your printer user guide for details. See www.kodak.com/go/z712accessories to order cables.)

Printing from a PictBridge enabled printer

- 1 Turn on the printer. Turn on the camera.

The PictBridge logo is displayed, followed by the current picture and menu. (If no pictures are found, a message is displayed.) If the menu interface turns off, press any button to redisplay it.

- 2 Press ▲/▼ to choose a printing option, then press OK.

Current Picture—Press ◀/▶ to choose a picture. Choose the number of copies.

Tagged Pictures—If your printer is capable, print pictures that you tagged for printing.

Index Print—Print thumbnails of all pictures. This requires one or more sheets of paper. If the printer is capable, choose a print size.

All Pictures—Print all pictures in internal memory, on a card, or in Favorites. Choose the number of copies.

Image Storage—Access Internal/Card or Favorites.

NOTE: During direct printing, pictures are not permanently transferred or saved to the computer or printer. To transfer pictures to your computer, see [page 43](#). In Favorites mode, the current favorite picture is displayed.

Disconnecting the camera from a PictBridge enabled printer

- 1 Turn off the camera and printer.
- 2 Disconnect the USB cable from the camera and the printer.

Ordering prints online

Kodak EasyShare Gallery is one of the many online print services offered in EasyShare software. You can easily:

- Upload your pictures.
- Edit, enhance, and add borders to your pictures.
- Store pictures, and share them with family and friends.
- Order high-quality prints, photo greeting cards, frames, and albums—and have them delivered to your door.

Printing pictures from your computer

For details on printing pictures from your computer, see EasyShare software Help.

Printing from an optional SD or MMC card

- Automatically print tagged pictures when you insert your card into a printer with an SD/MMC slot. See your printer user's guide for details.
- Make prints at an SD/MMC card-capable Kodak picture maker/picture kiosk. (Contact a location before visiting. See www.kodak.com/go/picturemaker.)
- Take the card to your local photo retailer for professional printing.

Accessories for your camera

To see which EasyShare camera and printer docks are compatible with your camera, visit www.kodak.com/go/adaptorkitchart.

To purchase camera docks, printer docks, chargers, and other accessories, visit www.kodak.com/go/z712accessories.

6

Troubleshooting

Camera problems

For step-by-step product support, visit www.kodak.com/go/z712support and select Interactive Troubleshooting & Repairs.

If	Try one or more of the following
Camera does not turn on	<ul style="list-style-type: none"> ■ Insert a new or charged battery. ■ If practical, connect the camera to a Kodak 3-volt AC adapter (sold separately), then try again. See page 58 for more battery information.
Camera does not turn off and the lens does not retract	
Camera buttons and controls do not function	
Lens does not extend when camera turns on or does not retract	<ul style="list-style-type: none"> ■ Confirm that the battery in camera is charged. ■ Turn camera off, then on again. (Lens does not extend in Favorites mode.) ■ If problem still exists, get help (page 52).
EVF/LCD is black or does not turn on	<ul style="list-style-type: none"> ■ Remove the lens cap. ■ Push the EVF/LCD button to change the display.
In Review, a blue or black screen is displayed instead of a picture	<ul style="list-style-type: none"> ■ Transfer the picture to the computer. ■ Transfer <i>all</i> pictures to the computer (page 44). ■ Take another picture. If problem continues, try internal memory and/or another memory card.
Pictures remaining number does not decrease after taking a picture	<ul style="list-style-type: none"> ■ Continue taking pictures. The camera is operating normally. (The camera estimates the number of pictures remaining after each picture is taken, based on picture size and content.)

If	Try one or more of the following
Picture orientation is not accurate	<ul style="list-style-type: none"> ■ Set the Orientation Sensor to ON (see page 32)
Flash does not fire	<ul style="list-style-type: none"> ■ Open the flash unit (page 9). ■ Check the flash setting and change as needed (page 9). <p>NOTE: The flash does not fire in all modes.</p>
Storage location is almost or entirely full	<ul style="list-style-type: none"> ■ Transfer pictures to the computer (page 44). ■ Delete pictures from the card (page 17) or insert a new card. ■ Change image storage location to internal memory (see page 31).
Battery life is short	<ul style="list-style-type: none"> ■ Make sure the correct battery type is installed (page 58). ■ Wipe the contacts with a clean, dry cloth before inserting a battery in the camera. ■ Insert a new or charged battery (page 2).
You cannot take a picture	<ul style="list-style-type: none"> ■ Turn camera off, then on again. Make sure the camera is not in Favorites mode. If prompted, set language and date/time. ■ Press Shutter button all the way (page 5). ■ Insert a new or charged battery (page 2). ■ Wait until the AF/AE indicator turns green before attempting to take another picture. ■ Memory full. Transfer pictures to the computer (page 44), delete pictures (page 17), change image storage location (see page 31), or insert another card.
Error message appears on EVF/LCD	<ul style="list-style-type: none"> ■ Follow the EVF/LCD prompts. ■ Remove memory card from the camera. ■ Turn the camera off, then on again. ■ Remove the battery and wipe the contacts with a clean, dry cloth. ■ Insert a new or charged battery (page 2). ■ Get customer support help (page 52).

If	Try one or more of the following
Memory card not recognized or camera freezes with card.	<ul style="list-style-type: none"> ■ Card may be corrupted. Format card in camera (see page 33.) ■ Change image storage location to internal memory (see page 31.)

Computer/connectivity problems

If	Try one or more of the following
Computer does not communicate with the camera	<ul style="list-style-type: none"> ■ Insert a charged battery (page 2.) ■ Turn on the camera. ■ Make sure the proper USB cable is connected on camera and computer port (page 44.) (If using an EasyShare dock, check all cable connections. Make sure the camera is seated on the dock.) ■ Make sure the EasyShare software is installed (page 43.)
Pictures do not transfer to computer	<ul style="list-style-type: none"> ■ Click the Help button in the EasyShare software.
Slide Show does not run on an external video device	<ul style="list-style-type: none"> ■ Adjust the camera Video Out setting (see page 32.) ■ Make sure the external device settings are correct (see the device's user's guide).

Picture quality problems

If	Try one or more of the following
Picture is too dark	<ul style="list-style-type: none"> ■ Reposition camera for more available light. ■ Use Fill flash (page 9) or change your position so light is not behind the subject. ■ Move so that the distance between you and the subject is within the effective flash range (page 9). ■ To automatically set exposure and focus, press the Shutter button halfway. When the AF/AE indicator turns green, press the Shutter button completely down to take the picture. ■ If using P, A, or S mode, adjust exposure compensation (page 35).

If	Try one or more of the following
Picture is too light	<ul style="list-style-type: none"> ■ Reposition camera to reduce the amount of available light. ■ Turn flash off (page 9). ■ Move so that the distance between you and the subject is within the effective flash range (page 9). ■ To automatically set exposure and focus, press the Shutter button halfway. When the AF/AE indicator turns green, press the Shutter button completely down to take the picture. ■ If using P, A, or S mode, adjust Exposure compensation (page 36).
Picture is not clear	<ul style="list-style-type: none"> ■ To automatically set exposure and focus, press the Shutter button halfway. When the AF/AE indicator turns green, press the Shutter button completely down to take the picture. ■ Clean the lens (page 56). ■ Make sure camera is not in Close-up/Macro mode if you are more than 27.6 in. (70 cm) from your subject. (Move further away if you are using the zoom lens in Close-up/Macro.) ■ Place the camera on a flat, steady surface or use a tripod, especially in high-zoom settings or in low light.

Direct printing (PictBridge) problems

If	Try one or more of the following
Cannot locate desired picture.	<ul style="list-style-type: none"> ■ Turn on the camera. Make sure the camera is accessing internal memory/card or Favorites. ■ If you are using Direct print, use the menu to change the image storage location.
The Direct print menu interface turns off.	Press any button to redisplay the menu.
Cannot print pictures.	<ul style="list-style-type: none"> ■ Ensure that there is a connection between camera and printer (page 44). ■ Ensure the printer and camera have power.

7

Getting help

Helpful links

Camera

Email Kodak customer support	www.kodak.com/go/contact
Get support for your product (FAQs, troubleshooting information, arrange for repairs, etc.)	www.kodak.com/go/z712support
Purchase camera accessories (camera docks, printer docks, lenses, cards, chargers, etc.)	www.kodak.com/go/z712accessories
Download the latest camera firmware and software	www.kodak.com/go/z712downloads
See online demonstrations of your camera	www.kodak.com/go/howto

Software

Get information on EasyShare software	www.kodak.com/go/easysharesw (or click Help in EasyShare software)
Get help with the Windows operating system and working with digital pictures	www.kodak.com/go/pcbasics

Other

Get support for other cameras, software, accessories, more	www.kodak.com/go/support
Get information on Kodak EasyShare printer docks	www.kodak.com/go/printerdocks
Get information on Kodak inkjet products	www.kodak.com/go/inkjet
Optimize your printer for truer, more vibrant colors	www.kodak.com/go/onetouch
Register your camera	www.kodak.com/go/register

NOTE: If you have questions concerning this product, you may speak with Kodak customer support.

Australia	1800 267 588	Netherlands	020 346 9372
Austria	0179 567 357	New Zealand	0800 880 120
Belgium	02 713 14 45	Norway	23 16 21 33
Brazil	0800 891 42 13	Philippines	1 800 1 888 9600
Canada	1 800 465 6325	Poland	00800 4411625
China	800 820 6027	Portugal	021 415 4125
Denmark	3 848 71 30	Russia	8 495 929 9166
Ireland	01 407 3054	Singapore	800 6363 036
Finland	0800 1 17056	Spain	91 749 76 53
France	01 55 1740 77	Sweden	08 587 704 21
Germany	069 5007 0035	Switzerland	01 838 53 51
Greece	00800 44140775	Taiwan	0800 096 868
Hong Kong	800 901 514	Thailand	001 800 631 0017
India	91 80 41374555 (toll free 000800 440 1227)	Turkey	00800 448827073
Italy	02 696 33452	United Kingdom	0870 243 0270
Japan	03 5540 9002	United States	1 800 235 6325
Korea	080 708 5600	International Toll Line	+44 131 458 6714
		International Toll Fax	+44 131 458 6962

Camera specifications

CCD—1/2.5 in. CCD, 4:3 aspect ratio

Picture size—

7.1 MP: 3072 x 2304 pixels

6.3 MP (3:2): 3072 x 2048 pixels

5.0 MP: 2592 x 1944 pixels

3.1 MP: 2048 x 1536 pixels

2.2 MP (3:2): 1800 x 1200 pixels

2.1 MP (16:9): 1920 x 1080 pixels

1.2 MP: 1280 x 960 pixels

Color display—2.5 in. (6.4 cm) color LCD; 480 x 240 (115 K) pixels

Color electronic viewfinder—0.2 in. (5.1 mm), 230 K pixels

Taking lens—12X optical zoom, aspheric all-glass lens, f/2.8–4.8 (35 mm equivalent: 36–432 mm)

Accessory lens thread—Yes

Lens protection—Lens cap

Digital zoom—4.2X; combined zoom settings up to 50X in 0.2X increments. (Not supported for movie capture.)

Focus system—TTL-AF; multi-zone, center-zone, selectable zone. Working range:

Auto: 19.7 in. (50 cm)—infinity @ wide; 47.2 in. (120 cm)—infinity @ telephoto

Close-up/Macro: 4.7–23.7 in. (12–60cm) @ wide; 7.9–51.2 in. (60–130 cm) @ telephoto

Exposure metering—Multi-pattern, Center-weight, Spot

Exposure compensation—+/-2.0 EV with 1/3 EV step

Shutter speed—

Smart Scene: 1/2–1/1000 sec.

Shutter priority and Manual mode: 16–1/1000 sec.

ISO speed—

Auto: 64 to 400

Selectable: 64, 100, 200, 400, 800, 1600, 3200 (3200 available only at 1.2 MP)

Electronic flash—Guide no. 11 (@ ISO 100); auto flash with pre-flash control.

Working range:

Wide: 1.6–25.6 ft (0.5–7.8 m)

Tele: 4–14.4 ft (1.2–4.4 m)

Flash modes—Auto, Fill, Red Eye, Off**Capture modes—**Smart Scene, Sport, SCN (Scene), Video, P, A, S, M, High-ISO

Burst mode—First burst up to 6 pictures; Last burst up to 6 pictures; both @ approx. 2 fps (AE, AF, AWB executed for first shot only)

Video capture—

VGA (640 x 480) @ 30 fps

QVGA (320 x 240) @ 30 fps

Image file format—

Still: EXIF 2.2.1 (JPEG compression); file organization DCF

Video: QuickTime (CODEC MPEG-4)

Image storage—Optional MMC or SD Card  (The SD logo is a trademark of the SD Card Association.)

Internal storage capacity—32 MB internal memory (27.7 MB available for image storage. 1 MB equals one million bytes.)

Quickview—Yes

Video output—NTSC or PAL

Power—Kodak lithium digital camera battery CRV3; Kodak Li-Ion rechargeable digital camera battery KLIC-8000; AA lithium batteries; 3V AC adapter; EasyShare dock

Communication with computer—USB 2.0 full speed (PIMA 15740 protocol), via USB cable (U-8), EasyShare dock

PictBridge support—Yes

Self-timer—2 seconds, 10 seconds, 2-shot

White Balance—Auto, Daylight, Open Shade, Tungsten, Fluorescent (available only in PASM)

Color modes—High Color, Natural Color, Low Color, Black & White, Sepia

Date stamp—On, Off

Tripod mount—1/4 inch

Operating temperature—32–104° F (0–40° C)

Size—4.1 x 2.9 x 2.7 in. (10.4 x 7.4 x 6.9 cm) @ power off

Weight—10.6 oz (300 g) without card or battery

Care and maintenance

- If you suspect water has gotten inside the camera, remove the battery and card. Allow all components to air-dry for at least 24 hours before using the camera.
- Blow gently on the lens or LCD to remove dust and dirt. Wipe gently with a soft, lint-free cloth or an untreated lens-cleaning tissue. Do not use cleaning solutions unless designed specifically for camera lenses. Do not allow chemicals, such as suntan lotion, to contact painted surfaces.
- Service agreements may be available in your country. Contact a dealer of Kodak products for more information.
- For digital camera disposal or recycling information, contact your local authorities. In the US, visit the Electronics Industry Alliance Web site at www.eiae.org or www.kodak.com/go/z712support.

Storage capacities

The LCD displays the approximate number of pictures (or minutes/seconds of video) remaining. For average SD card capacities, visit www.kodak.com/go/memory (and click the SD card). Actual storage capacity varies depending on subject composition, card size, and other factors. You may be able to store more or fewer pictures and videos. Favorites take up additional space in internal memory.

Important safety instructions



CAUTION:

Do not disassemble this product; there are no user-serviceable parts inside. Refer servicing to qualified service personnel. Kodak AC adapters and battery chargers are intended for indoor use only. The use of controls, adjustments, or procedures other than those specified herein may result in exposure to shock and/or electrical or mechanical hazards. If the LCD breaks, do not touch the glass or liquid. Contact Kodak customer support.

- The use of an accessory that is not recommended by Kodak may cause fire, electric shock, or injury. For approved accessories, visit www.kodak.com/go/accessories.
- Use only a USB-certified computer equipped with a current-limiting motherboard. Contact your computer manufacturer if you have questions.
- If using this product in an airplane, observe all instructions of the airline.
- When removing the battery, allow it to cool; it may be hot.
- Follow all warnings and instructions supplied by the battery manufacturer.
- Use only batteries approved for this product to avoid risk of explosion.
- Keep batteries out of the reach of children.
- Do not allow batteries to touch metal objects, including coins. Otherwise, a battery may short circuit, discharge energy, become hot, or leak.
- Do not disassemble, install backward, or expose batteries to liquid, moisture, fire, or extreme temperature.

- Remove the battery when the product is stored for an extended period of time. In the unlikely event that battery fluid leaks inside the product, contact Kodak customer support.
- In the unlikely event that battery fluid leaks onto your skin, wash immediately with water and contact your local health provider. For additional health-related information, contact your local Kodak customer support.
- Dispose of batteries according to local and national regulations. Visit www.kodak.com/go/kes.
- Do not charge non-rechargeable batteries. Visit www.kodak.com/go/batterytupes.

Battery life

Use these Kodak batteries. (Battery types are also molded into battery door.)

Kodak Li-Ion rechargeable digital camera battery KLIC-8000
Kodak lithium digital camera battery CRV3 (non-rechargeable)
AA lithium batteries

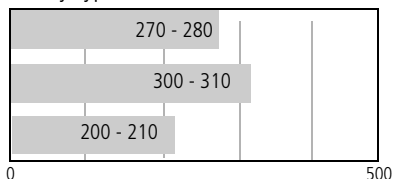

Battery life per CIPA testing method (Approx. number of pictures). Actual life may vary based on usage.

Extending battery life

- Use power-saving features (see [Using the Setup menu, page 31](#)). Limit activities such as reviewing pictures/videos on the LCD.
- Dirt on the battery contacts can affect battery life. Wipe the contacts with a clean, dry cloth before loading the battery in the camera.
- Battery performance is reduced at temperatures below 41° F (5° C). When using your camera in cold weather, carry spare batteries and keep them warm. Do not discard cold batteries that do not work; when they return to room temperature, they may be usable.

Upgrading your software and firmware

Download the latest versions of the software included on the Kodak EasyShare software CD and the camera firmware (the software that runs on the camera). See www.kodak.com/go/z712downloads.

Limited warranty

Kodak warrants Kodak consumer electronic products and accessories ("Products"), excluding batteries, to be free from malfunctions and defects in both materials and workmanship for one year from the date of purchase. Retain the original dated sales receipt. Proof of the date of purchase will be required with any request for warranty repair.

Limited warranty coverage

Warranty service is only available from within the country where the Products were originally purchased. You may be required to ship Products, at your expense, to the authorized service facility for the country where the Products were purchased. Kodak will repair or replace Products if they fail to function properly during the warranty period, subject to any conditions and/or limitations stated herein. Warranty service will include all labor as well as any necessary adjustments and/or replacement parts. If Kodak is unable to repair or replace a Product, Kodak will, at its option, refund the purchase price paid for the Product provided the Product has been returned to Kodak along with proof of the purchase price paid. Repair, replacement, or refund of the purchase price are the sole remedies under the warranty. If replacement parts are used in making repairs, those parts may be remanufactured, or may contain remanufactured materials. If it is necessary to replace the entire Product, it may be replaced with a remanufactured Product. Remanufactured Products, parts and materials are warranted for the remaining warranty term of the original Product, or 90 days after the date of repair or replacement, whichever is longer.

Limitations

This warranty does not cover circumstances beyond Kodak's control.

This warranty does not apply when failure is due to shipping damage, accident, alteration, modification, unauthorized service, misuse, abuse, use with incompatible accessories or attachments (such as third party ink or ink tanks), failure to follow Kodak's operation, maintenance or repacking instructions, failure to use items supplied by Kodak (such as adapters and cables), or claims made after the duration of this warranty. Kodak makes no other express or implied warranty for this product, and disclaims the implied warranties of merchantability and fitness for a particular purpose. In the event that the exclusion of any implied warranty is ineffective under the law, the duration of the implied warranty will be one year from the purchase date or such longer period as required by law. The option of repair, replacement, or refund is Kodak's only obligation. Kodak will not be responsible for any special, consequential or incidental damages resulting from the sale, purchase, or use of this product regardless of the cause. Liability for any special, consequential or incidental damages (including but not limited to loss of revenue or profit, downtime costs, loss of the use of the equipment, cost of substitute equipment, facilities or services, or claims of your customers for such damages resulting from the purchase, use, or failure of the Product), regardless of cause or for breach of any written or implied warranty is expressly disclaimed.

Your rights

Some states or jurisdictions do not allow exclusion or limitation of incidental or consequential damages, so the above limitation or exclusion may not apply to you. Some states or jurisdictions do not allow limitations on how long an implied warranty lasts, so the above limitation may not apply to you. This warranty gives you specific rights, and you may have other rights which vary from state to state or by jurisdiction.

Outside the United States and Canada

In countries other than the United States and Canada, the terms and conditions of this warranty may be different. Unless a specific Kodak warranty is communicated to the purchaser in writing by a Kodak company, no warranty or liability exists beyond any minimum requirements imposed by law, even though defect, damage, or loss may be by negligence or other act.

Regulatory compliance

FCC compliance and advisory



Kodak EasyShare Z712 IS zoom digital camera

This equipment has been tested and found to comply with the limits for a Class B digital device, pursuant to Part 15 of the FCC Rules. These limits are designed to provide reasonable protection against harmful interference in a residential installation.

This equipment generates, uses, and can radiate radio frequency energy and, if not installed or used in accordance with the instructions, may cause harmful interference to radio communications. However, there is no guarantee that interference will not occur in a particular installation.

If this equipment does cause harmful interference to radio or television reception, which can be determined by turning the equipment off and on, the user is encouraged to try to correct the interference by one or more of the following measures: 1) reorient or relocate the receiving antenna; 2) increase the separation between the equipment and the receiver; 3) connect the equipment to an outlet on a circuit different from that to which the receiver is connected; 4) consult the dealer or an experienced radio/TV technician for additional suggestions.

Any changes or modifications not expressly approved by the party responsible for compliance could void the user's authority to operate the equipment. Where shielded interface cables have been provided with the product or specified additional components or accessories elsewhere defined to be used with the installation of the product, they must be used in order to ensure compliance with FCC regulation.

MPEG-4

Use of this product in any manner that complies with the MPEG-4 visual standard is prohibited, except for use by a consumer engaging in personal and non-commercial activities.

Canadian DOC statement

DOC Class B Compliance—This Class B digital apparatus complies with Canadian ICES-003.

Observation des normes-Classe B—Cet appareil numérique de la classe B est conforme à la norme NMB-003 du Canada.

Australian C-Tick



Waste Electrical and Electronic Equipment labeling



In the European Union, do not discard this product as unsorted municipal waste. Contact your local authorities or go to www.kodak.com/go/recycle for recycling program information.

China RoHS

环保使用期限 (EPUP)

在中国大陆, 该值表示产品中存在的任何危险物质不得释放, 以免危及人身健康、财产或环境的时间期限(以年计)。该值根据操作说明中所规定的产品正常使用而定。

有毒有害物质或元素名称及含量标识表						
部件名称	有毒有害物质或元素					
	铅	汞	镉	六价铬	多溴联苯	多溴二苯醚
数码相机电路板元件	×	○	○	○	○	○

○：表示该有毒有害物质在该部件所有均质材料中的含量均在SJ/T 11363-2006规定的限量要求以下。
 ×：表示该有毒有害物质至少在该部件的某一均质材料中的含量超出SJ/T 11363-2006规定的限量要求。



USB 数据线



音频/视频电缆

VCCI Class B ITE

この装置は、情報処理装置等電波障害自主規制協議会（VCCI）の基準に基づくクラスB情報技術装置です。この装置は、家庭環境で使用することを目的としていますが、この装置がラジオやテレビジョン受信機に近接して使用されると、受信障害を引き起こすことがあります。
取扱説明書に従って正しい取り扱いをして下さい。

Korean Class B ITE

이 기기는 가정용으로 전자파적합등록을 한 기기로서 주거지역에서는 물론 모든 지역에서 사용할 수 있습니다.

Russian GOST-R



Eastman Kodak Company
Rochester, NY 14650

A10-40

Фотокамера изготовлена в Китае; остальные элементы -
в соответствии с маркировкой.

Index

A

- A/V out, 22
- about this camera, 33
- accessories
 - battery, 58
 - buying, 47
 - picture transfer, 44
 - printer dock, 45
 - SD/MMC card, 4
- AF control, 30
- album
 - set, 31
 - tagging pictures for, 42
- aperture priority, 35
- auto
 - enhancement, 18
 - flash, 9
 - focus framing marks, 6

B

- backlight, 28
- batteries
 - expected life, 58
 - extending life, 58
 - loading, 2
 - types, 58
- beach, 27
- burst, using, 12
- button
 - delete, ii
 - drive, 12, 13
 - EVF/LCD, ii

- flash, i, 9
- focus, 10
- info, ii
- menu, ii, 28
- review, ii, 16
- share, ii
- zoom, ii, 8

C

- cable
 - audio/video, 22
 - USB, 44
- camera sounds, 32
- candle light, 28
- care and maintenance, 56
- children, 27
- clock, setting, 3
- close-up, 10
- color mode, 30
- compression, 29
- computer
 - connecting camera, 43
 - transfer to, 43
- copy pictures
 - card to memory, 24
 - memory to card, 24
 - to computer via USB cable, 43
- cropping pictures, 18
- CRV3 battery, loading, 2
- customer support, 53
- customizing camera settings, 31

D

- date setting, 3
- date stamp, 30
- DC-in, ii
- delete button, ii
- deleting
 - from internal memory, 17
 - from SD/MMC card, 17
 - protecting pictures, videos, 17
- digital zoom, using, 8
- displaying slide show, 21
- disposal, recycling, 56
- distant scenes, 10
- dock
 - connector, ii
 - printer, 45
- downloading pictures, 43

E

- edit videos, 19
- emailing pictures, videos, 38
- EVF (electronic viewfinder), ii
- EVF/LCD button, ii
- expected battery life, 58
- exposure
 - bracketing, 13
 - bracketing interval, 29
 - compensation, 35
 - metering, 29
- external video device
 - viewing pictures, videos, 22

F

- favorites

- settings, 40
- tagging, 39
- fireworks, 27
- firmware, upgrading, 59
- flash, i
 - button, i
 - settings, 9
- flower, 27
- focus
 - close-up, 10
 - framing marks, 6
 - landscape, 10
 - manual, 10
 - zone, 30
- format card, internal memory, 33
- framing grid, 31

G

- getting camera help, 13
- guidelines, battery, 58

H

- HDTV format, 28
- help
 - camera help, 13
 - web links, 52
- high-ISO, 26
- histogram, 20

I

- icons, mode dial, 26
- image stabilizer, 31
- image storage, 31
- info button, ii
- installing

- batteries, 2
 - SD/MMC card, 4
 - software, 43
- internal memory
 - storage capacity, 57

K

- Kodak EasyShare software
 - installing, 43
 - upgrading, 59
- Kodak Perfect Touch technology, 18
- Kodak Web sites, 52

L

- landscape, 10, 27
- language, 32
- LCD, ii
 - brightness, 31
 - reviewing pictures, 16
 - reviewing videos, 16
- lens, i
 - cap, 1
 - cleaning, 56
- liveview, 31
- loading
 - batteries, 2
 - SD/MMC card, 4
 - software, 43

M

- Mac OS, installing software, 43
- maintenance, camera, 56
- make picture from video, 19
- manner/museum, 27
- manual, 35

- manual focus, 10
- memory
 - inserting card, 4
- menu button, ii, 28
- microphone, i
- mode dial, 26
- modes
 - aperture priority, 35
 - backlight, 28
 - beach, 27
 - candle light, 28
 - children, 27
 - fireworks, 27
 - flower, 27
 - high-ISO, 26
 - landscape, 27
 - manner/museum, 27
 - manual, 35
 - night landscape, 27
 - night portrait, 27
 - portrait, 27
 - SCN (scene), 26
 - shutter priority, 35
 - smart scene, 26
 - snow, 27
 - sports, 26
 - sunset, 28
 - text, 27
- multiple selections, 23
- multi-up, 22

N

- night landscape, 27
- night portrait, 27

O

online prints, ordering, 47
open flash switch, i
optical zoom, 8
orientation sensor, 32

P

panoramic pictures, 34
PASM mode, 35
Perfect Touch technology, 18
PictBridge printer, 45
picture quality, 28
pictures
 checking settings, 25
 copying, 24
 cropping, 18
 deleting, 17
 emailing tagged, 38
 Kodak Perfect Touch, 18
 printing, 47
 printing tagged, 37
 protecting, 17
 reviewing, 16
 tagging, 42
 taking, modes, 26
 transfer via USB cable, 43
portrait, 27
power, camera, 3
printer dock, 45
printing
 from a card, 47
 from computer, 47
 optimizing printer, 52
 order online, 47

PictBridge, 45
 tagged pictures, 47
 with EasyShare printer dock, 45
protecting pictures, videos, 17

R

recycling, disposal, 56
red eye, flash, 9
regulatory information, 61
repair, 52
reset camera, 33
review button, ii, 16
reviewing pictures, 16
 deleting, 17
 protecting, 17
 slide show, 21
reviewing videos, 16
 deleting, 17
 protecting, 17
 slide show, 21
running slide show, 21

S

safety, 57
scene (SCN) modes
 panorama, 34
SCN (scene), 26
SD/MMC card
 buying, 47
 inserting, 4
 printing from, 47
 slot, ii
 storage capacities, 57
select multiple pictures/videos, 23

self-timer, 11
service and support telephone
 numbers, 53
setting
 AF control, 30
 album, 31
 camera sounds, 32
 color mode, 30
 date and time, 3
 date stamp, 30
 exposure bracketing, 29
 exposure metering, 29
 flash, 9
 focus zone, 30
 framing grid, 31
 image stabilizer, 31
 image storage, 31
 language, 32
 LCD brightness, 31
 liveview, 31
 orientation sensor, 32
 picture quality, 28
 picture taking mode, 26
 reset camera, 33
 self-timer, 11
 sharpness, 30
 video date display, 32
 video out, 32
 white balance, 29
setup menu, using, 31
share button, ii
sharpness, 30
shutter
 priority, 35

 problems, 49
 self-timer delay, 21
 speed, 35
slide show
 continuous loop, 21
 problems, 50
 running, 21
smart scene, 26
snow, 27
software
 installing, 43
 upgrading, 59
specifications, camera, 54
sports, 26
storage capacities, 57
sunset, 28
support, technical, 53

T

tagging
 favorites, 39
 for albums, 42
 for email, 38
 for print, 37
telephone support, 53
television, slide show, 22
text, 27
time, setting, 3
timer, shutter delay, 11
tips
 battery guidelines, 58
 care & maintenance, 56
transfer, via USB cable, 43
trimming a video, 19

tripod socket, ii
troubleshooting, 48
turning camera on and off, 3

U

undelete, undo, 17
upgrading software, firmware, 59
URLs, Kodak Web sites, 52
USB (universal serial bus)
 transferring pictures, 43
USB, A/V out, ii

V

VCCI compliance, 63
video
 action print, 20
 checking settings, 25
 copying, 24
 date display, 32
 deleting, 17
 edit, 19
 emailing tagged, 38
 out, 32
 protecting, 17
 reviewing, 16
 size, 28
 transfer to computer, 43
 viewing, 16
viewfinder, ii
viewing
 by date, album, 23
 by multi-up, 22
viewing picture
 after taking, 16

W

warranty, 59
white balance, 29
Windows OS, installing software, 43

Z

zoom
 button, ii
 using, 8